

# SNARE MIC

QUICK START GUIDE

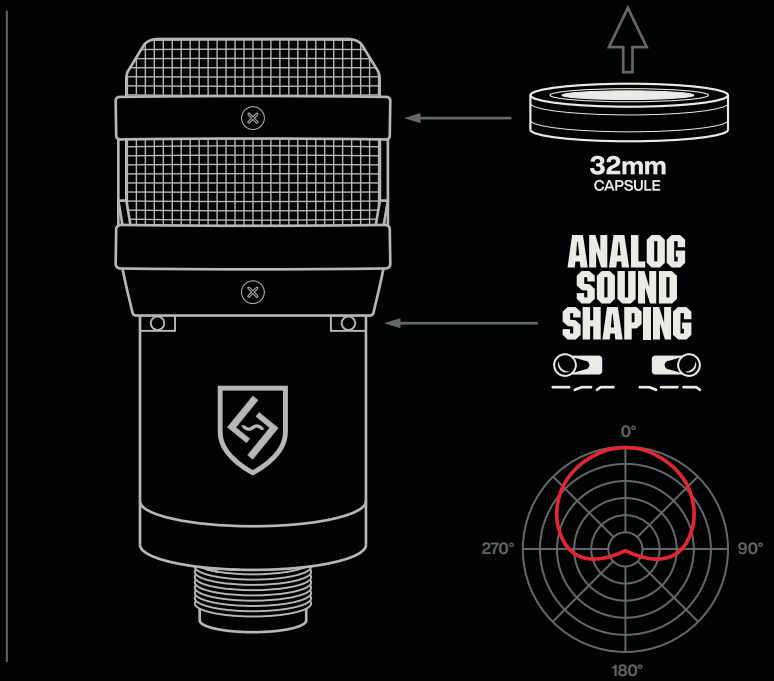

**SOUND SHAPING**

**FLAT/FLAT = HIGH IMPACT**

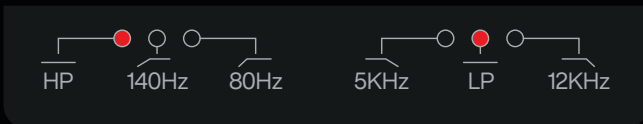

**80Hz/12kHz = EQ'D DYNAMIC MIC**

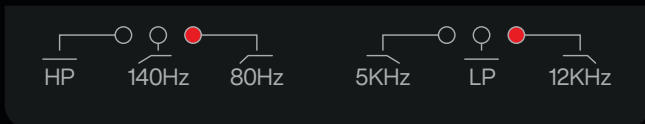

**140Hz/5kHz = BLEED DECIMATOR**

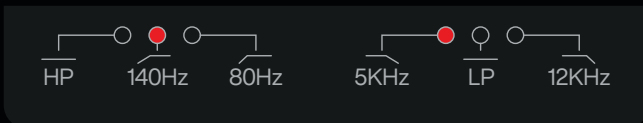

**140Hz/FLAT = BOTTOM SNARE**

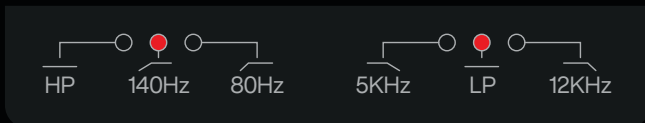

**MIC PLACEMENT**

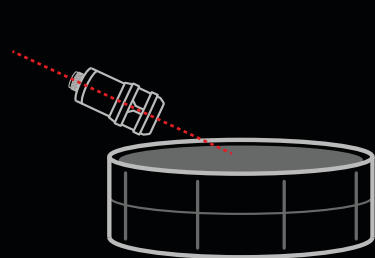

**20-30 Degrees**  
Increased crack & top head snap.

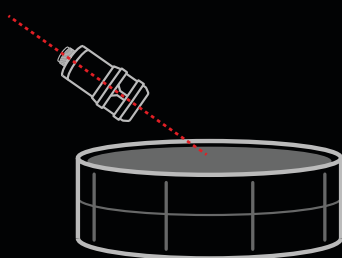

**30-40 Degrees**  
Bottom-end punch and increased midrange.

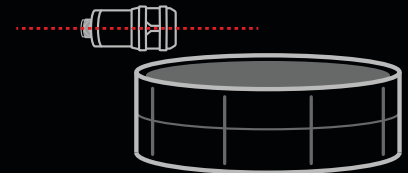

**0 Degrees**  
Maximum attack and impact.

**+48V**

**SNARE MIC REQUIRES 48V OF PHANTOM POWER TO WORK**